

BACK TO
OFFICE

KEEP SAFE
DISTANCE

Parkes

display | print | expo

CovidDeskScreens

Distancing Screen & Partition Solutions

Autumn 2020

t: 01767 603930

sales@**parkes**printgroup.com

Print
Gifts
Expo

parkesprintgroup.com

parkespromo.com

parkesexpo.com



Basic Screens with brackets

5mm Clear Acrylic with Desk/Counter
Top Fixing Bracket



- ✓ Clear easy to clean screens with rounded tops
- ✓ Includes EasyFit Desk Clamps
- ✓ Clamps fit up to 26mm desks - fast & easy attachment

Order Code	Description	1 off Price	5+ Price Each
750mm High Screens			
PK6601	800mm Wide x 750mm High	£99.97	£79.97
PK6602	1200mm Wide x 750mm High	£139.97	£119.97
PK6605	1400mm Wide x 750mm High	£149.97	£129.97
PK6603	1500mm Wide x 750mm High	£159.97	£139.97
PK6604	1600mm Wide x 750mm High	£209.97	£189.97

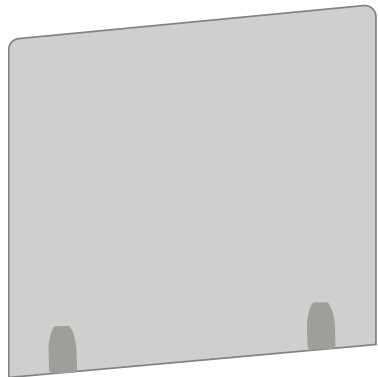

800mm wide x 750mm high

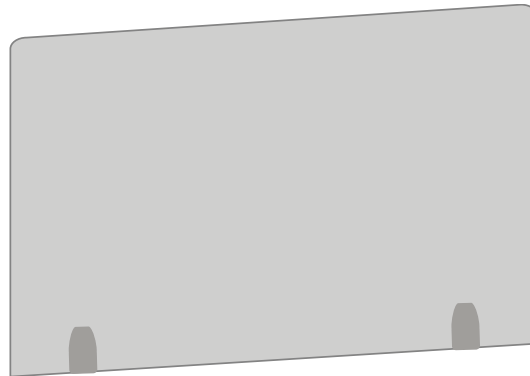

1200mm wide x 750mm high

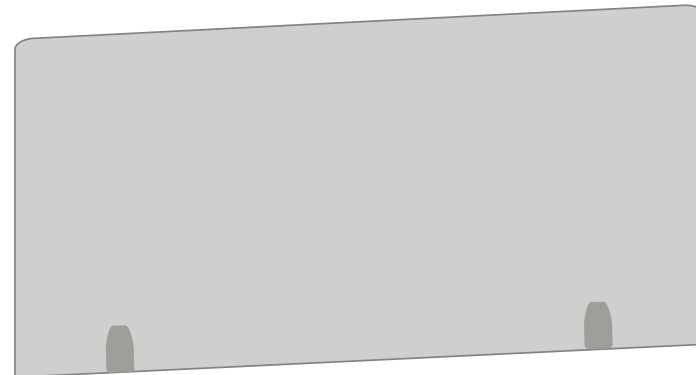

1500mm wide x 750mm high



Screens are supplied with easy fit desk clamp

BRANDING AND CUSTOM SIZES AVAILABLE – CALL FOR PRICES

Call us for more details: **01767 603930**

Premium Counter Screen

A 750/950mm high sneeze screen that can be easily added to any counter/desk, available with an optional card machine cut-out. Made from durable 5mm thick acrylic for self mounting. For added stability attach with high bond tape or screws.

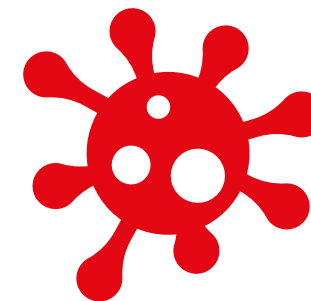

Order Code	Description	1 off Price	5+ Price Each
750mm High Screens			
PK6721	800mm Wide x 750mm High	£129.97	£109.97
PK6722	1200mm Wide x 750mm High	£159.97	£139.97
PK6723	1500mm Wide x 750mm High	£179.97	£159.97

Add **£15.00** for Cutout

950mm High Screens			
PK6731	800mm Wide x 950mm High	£149.97	£129.97
PK6732	1200mm Wide x 950mm High	£179.97	£159.97
PK6733	1500mm Wide x 950mm High	£199.97	£179.97

Add **£15.00** for Cutout

Roll of VHB (very high bond) tape **£12.50**

750mm High Screens

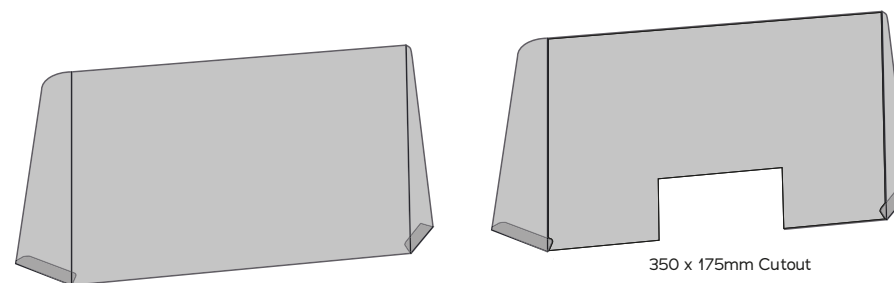

Front face size (overall width + 180mm
175mm Return (125mm deep front to back))

950mm High Screens

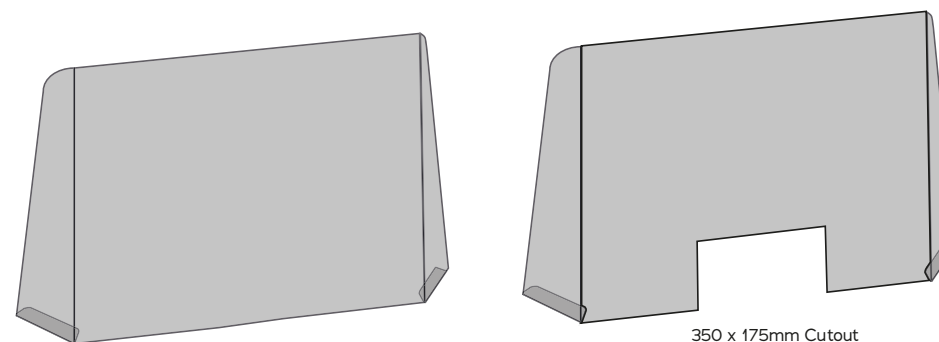

Front face size (overall width + 230mm
225mm Return (195mm deep front to back))

BRANDING AND CUSTOM SIZES AVAILABLE – CALL FOR PRICES

Premium Modular Screen

A 750/950mm high sneeze screen that can be easily added to any counter/desk, available with an optional card machine cut-out. Made from durable 5mm thick acrylic for self mounting. For added stability attach with high bond tape or screws.



Order Code	Standard Sizes	1 off Price	5+ Price Each
750mm High Screens			
PK6921	400mm Wide x 750mm High	£89.97	£69.97
PK6922	600mm Wide x 750mm High	£99.97	£79.97
PK6923	800mm Wide x 750mm High	£129.97	£109.97
PK6924	1200mm Wide x 750mm High	£149.97	£129.97
PK6925	1500mm Wide x 750mm High	£169.97	£149.97

Add **£15.00** for Cutout (available on 800/1200/1500mm wide options)

950mm High Screens			
Order Code	Standard Sizes	1 off Price	5+ Price Each
PK6931	400mm Wide x 950mm High	£109.97	£89.97
PK6932	600mm Wide x 950mm High	£119.97	£99.97
PK6933	800mm Wide x 950mm High	£149.97	£129.97
PK6934	1200mm Wide x 950mm High	£169.97	£149.97
PK6935	1500mm Wide x 950mm High	£189.97	£169.97

Add **£15.00** for Cutout (available on 800/1200/1500mm wide options)

Roll of VHB (very high bond) tape **£12.50**

750mm High Screens

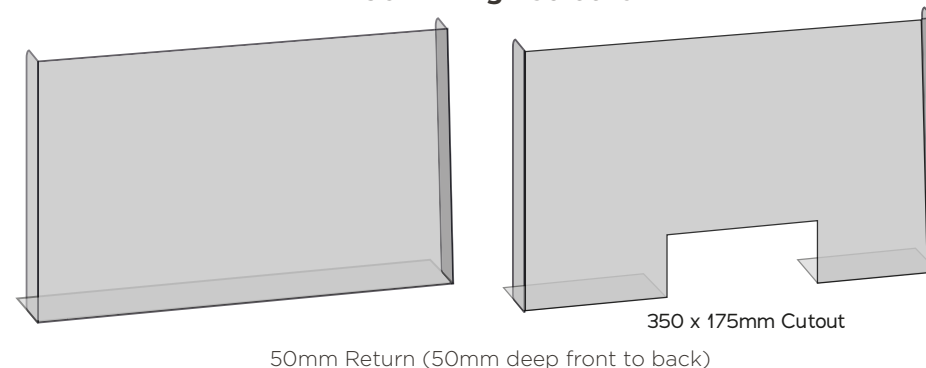

950mm High Screens

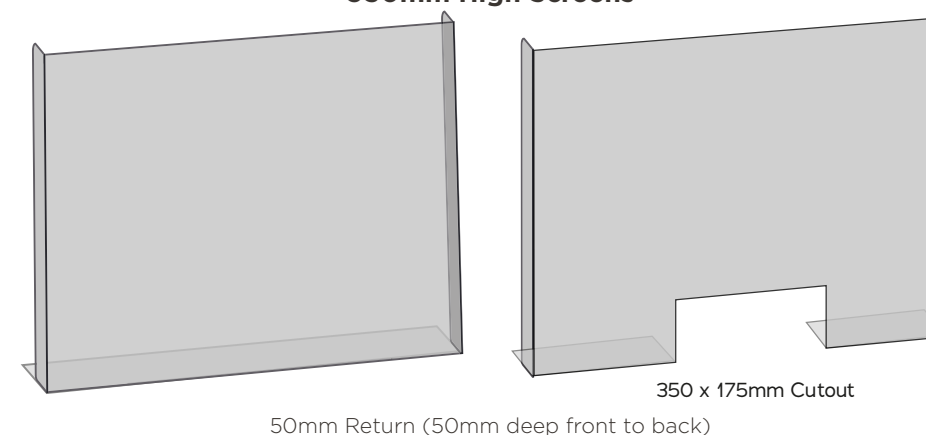

BRANDING AND CUSTOM SIZES AVAILABLE – CALL FOR PRICES

Call us for more details: **01767 603930**

Standard Screen

5mm Clear Acrylic Self Mounting available with an optional card machine cut-out. Can be Free standing for low use areas or VHB Taped or screwed through base return.

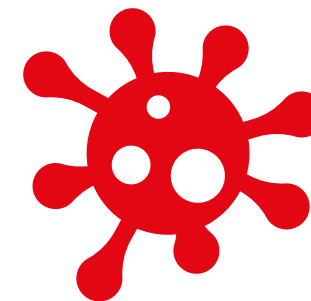

Order Code	Standard Sizes	1 off Price	5+ Price Each
750mm High Screens			
PK7121	400mm Wide x 750mm High	£69.97	£49.97
PK7122	600mm Wide x 750mm High	£79.97	£59.97
PK7123	800mm Wide x 750mm High	£99.97	£79.97
PK7126	1000mm Wide x 750mm High	£119.97	£99.97
PK7124	1200mm Wide x 750mm High	£129.97	£109.97
PK7125	1500mm Wide x 750mm High	£159.97	£139.97

Add **£15.00** for Cutout (available on 800/1200/1500mm wide options)

Roll of VHB (very high bond) tape **£12.50**

750mm High Screens

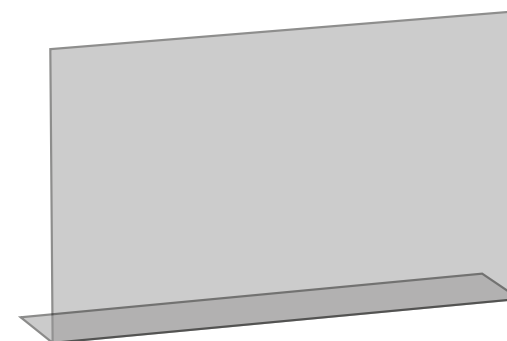

150mm Return (150mm deep front to back)

750mm High Screens with Cutout

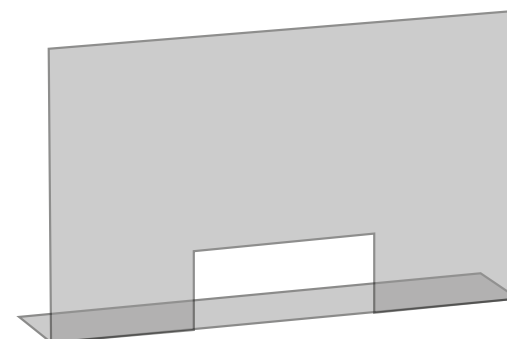

350 x 175mm Cutout

150mm Return (150mm deep front to back)

BRANDING AND CUSTOM SIZES AVAILABLE – CALL FOR PRICES

Standard Angled Counter Screen

5mm Clear Acrylic Self Mounting. Can be Free standing for low use areas or VHB Taped or screwed through base return.



Order Code	Standard Sizes	1 off Price	5+ Price Each
500mm High Screens			
PK7321	800mm Wide x 500mm High	£89.97	£69.97
PK7322	1000mm Wide x 500mm High	£109.97	£89.97
PK7323	1200mm Wide x 500mm High	£129.97	£109.97
PK7324	1500mm Wide x 500mm High	£149.97	£129.97
600mm High Screens			
PK7331	800mm Wide x 600mm High	£109.97	£89.97
PK7332	1000mm Wide x 600mm High	£129.97	£109.97
PK7333	1200mm Wide x 600mm High	£149.97	£129.97
PK7334	1500mm Wide x 600mm High	£179.97	£159.97
Roll of VHB (very high bond) tape £12.50			

500mm High Screens

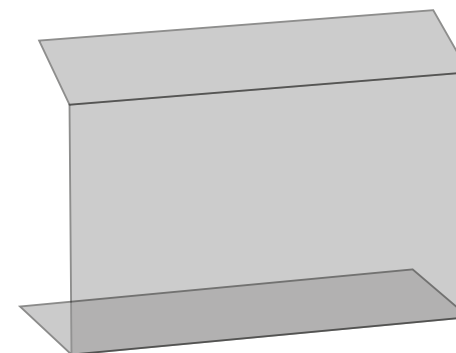

150mm Return (150mm deep front to back)

600mm High Screens

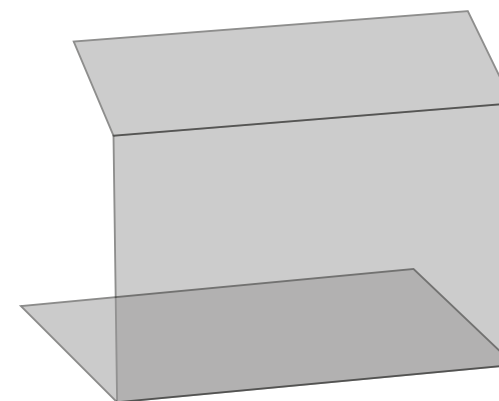

150mm Return (150mm deep front to back)

BRANDING AND CUSTOM SIZES AVAILABLE – CALL FOR PRICES

Call us for more details: **01767 603930**

BESPOKE SCREEN SOLUTIONS

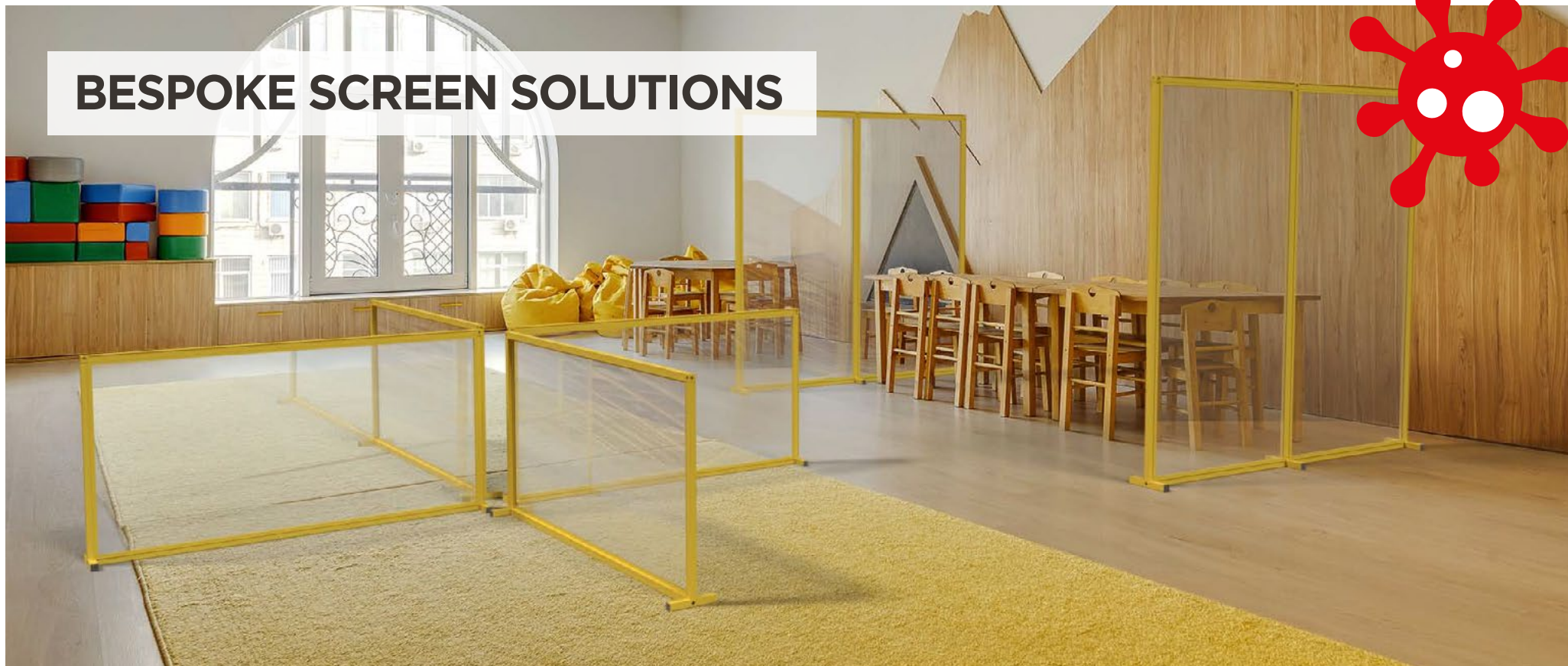
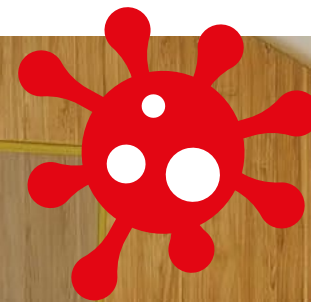

Call us for more details: **01767 603930**

Modular Walling



Branded Fabric Partitions

Great for internal branding and inspiring a great culture in the workplace

Use modular walling to separate desks and workstations. Designed as partitioning to protect and reduce risk between individuals. All desk partitions are fully customisable to meet exact requirements including sizing, materials and branding.

The modular benefits of the CubeLock system mean your solution can adapt to a range of different applications over time. Perfect for workspace layout changes, temporary storage solutions, partitions and dividers, semi-private zones, and more.

Combine with other social distancing products to create a complete protected environment.

Fabric partitions



Branded desk partitions from £2499.97



CUSTOMISE TO YOUR ENVIRONMENT WITH FABRIC GRAPHICS.

Parkes

display | print | expo

t: 01767 603930 sales@**parkes**printgroup.com

Parkes Print Group | 41 Hitchin Street | Biggleswade | Beds | SG18 8BE

Sneeze Screen Solutions SEPT2020

