



TECHNICAL GUIDE

YOUR GUIDE TO PRODUCING PROBLEM FREE FILES FOR PRINT

CONTENTS / CHECKLIST

This guide will cover the key elements you must be aware of when creating a file for print.

Please use this as a checklist when designing your job and submitting it for print.

contents

<input type="checkbox"/>	SIZES	page 3	<input type="checkbox"/>	PREPARING YOUR FILES	
<input type="checkbox"/>	FOLDED LEAFLETS	page 4	<input type="checkbox"/>	PDF CREATION	page 9
<input type="checkbox"/>	BLEED	page 5	<input type="checkbox"/>	DOWNLOADABLE TEMPLATES	page 9
<input type="checkbox"/>	COLOURS	page 6	<input type="checkbox"/>	COLOUR VARIATION	
<input type="checkbox"/>	SPOT COLOURS	page 6	<input type="checkbox"/>	COLOUR PROFILES	page 10
<input type="checkbox"/>	RGB COLOUR	page 6	<input type="checkbox"/>	PAPER STOCKS	page 10
<input type="checkbox"/>	OVERPRINT COLOURS	page 6	<input type="checkbox"/>	INK TOLERANCE	page 11
<input type="checkbox"/>	BLACK	page 6	<input type="checkbox"/>	LARGE FORMAT & DIGITAL	page 11
<input type="checkbox"/>	SPOT TO PROCESS	page 6	<input type="checkbox"/>	SPECIALIST PRINT	
<input type="checkbox"/>	VECTOR/BITMAP COLOURS	page 7	<input type="checkbox"/>	BOOKLETS	page 12
<input type="checkbox"/>	FOUNTAIN FILLS & TRANSPARENCIES	page 7	<input type="checkbox"/>	SPOT UV	page 12
<input type="checkbox"/>	INK COVERAGE	page 10	<input type="checkbox"/>	LARGE FORMAT	page 12
<input type="checkbox"/>	ARTWORK ELEMENTS		<input type="checkbox"/>	FORME CUT	page 13
<input type="checkbox"/>	IMAGES	page 8	<input type="checkbox"/>	FOLDERS	page 13
<input type="checkbox"/>	FONTS	page 8			
<input type="checkbox"/>	QUIET BORDER	page 8			
<input type="checkbox"/>	HAIRLINES	page 8			

how to send files to print

Upload your files online at point of order or to our file dropbox:
www.hightail.com/u/ParkesPrintDesign

the basics SIZES

Standard page sizes for your design jobs:

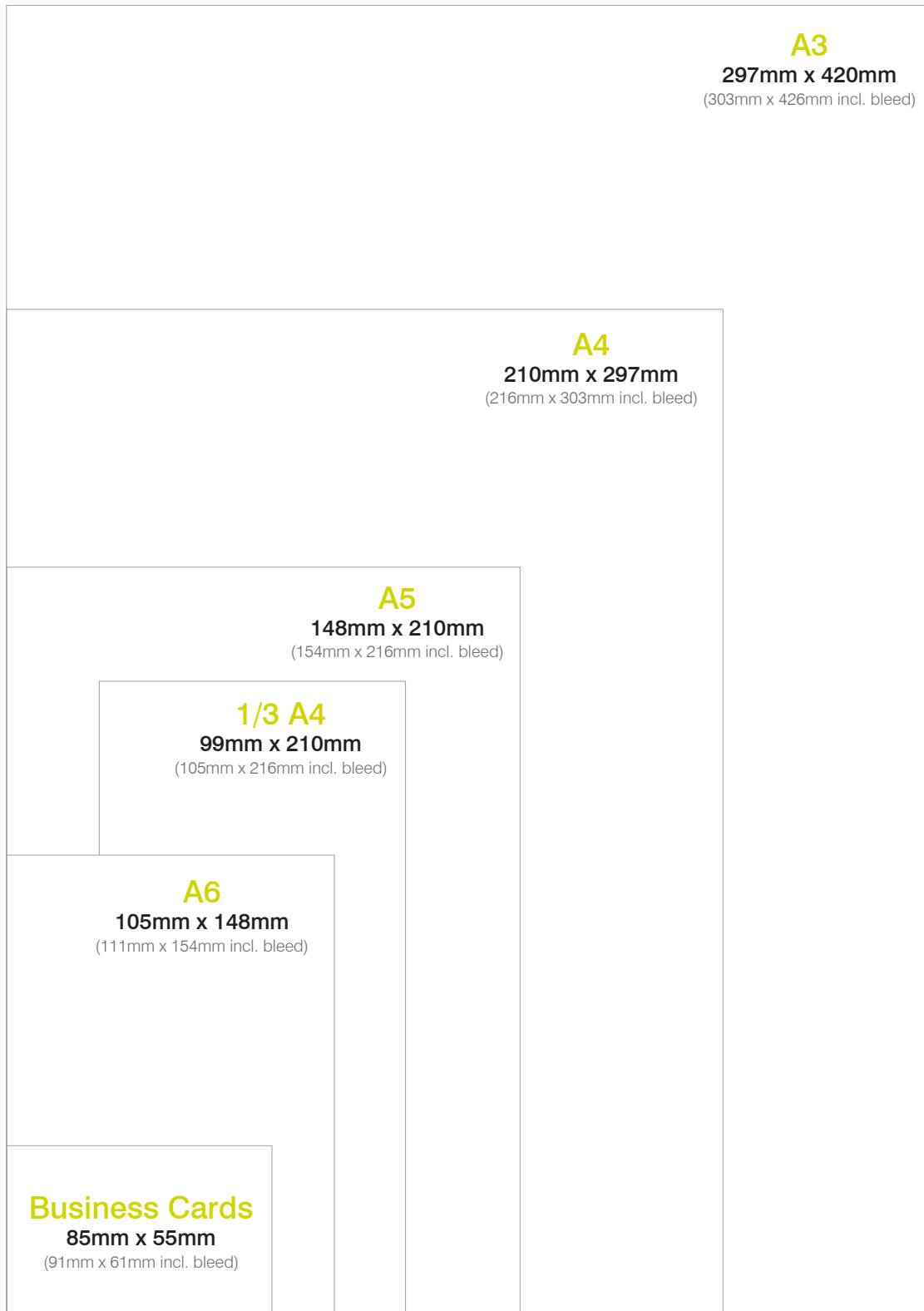

Other Sizes: **A2** 594mm x 420mm (600mm x 426mm incl. bleed)

A1 840mm x 594mm (846mm x 600mm incl. bleed)

FOLDED LEAFLETS

TRIFOLDS

A little more set up time is required when designing a Tri-fold leaflet. Below is a template showing the basic setup of the panels in your document

A4

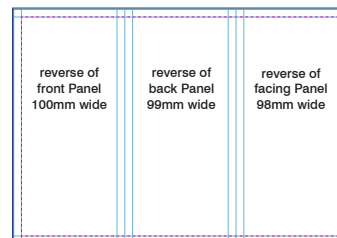
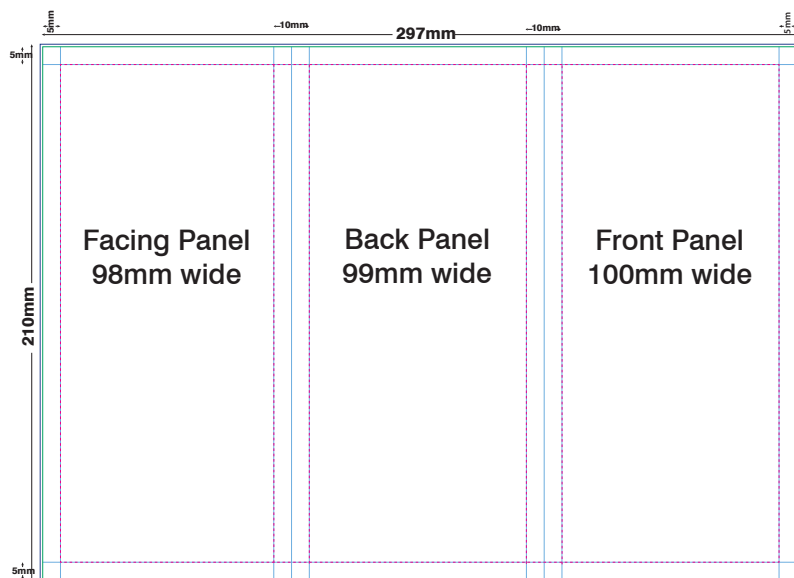

- no text beyond this line
- gutters and borders
- 3mm bleed
- finished page edges

A3

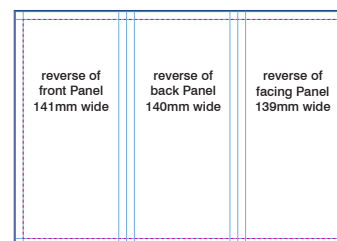
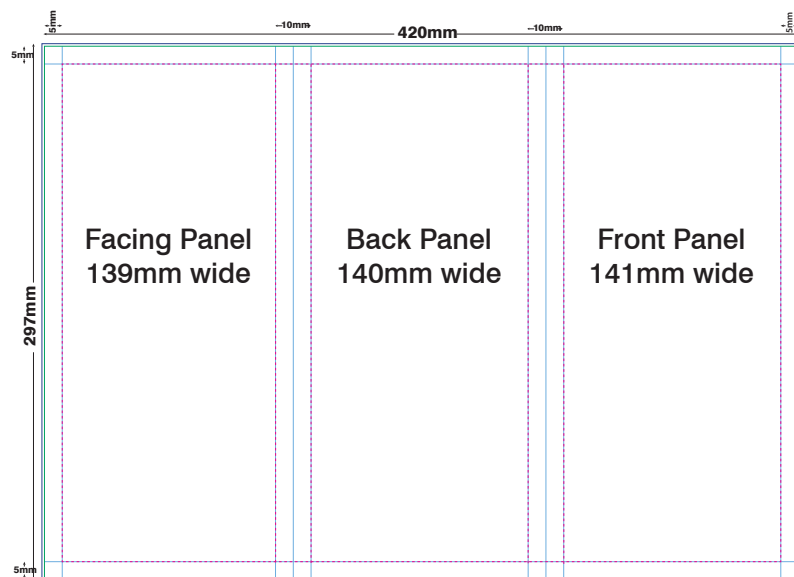

- no text beyond this line
- gutters and borders
- 3mm bleed
- finished page edges

SUPPLYING YOUR FOLDED LEAFLETS

When supplying artwork for a 4pp leaflet e.g. A4 folded to A5 please supply it as a 2-page PDF with the pages in pairs. So page 1 of your PDF would be pages 4 & 1 of the leaflet, page 2 of your PDF would be pages 2 & 3 of your leaflet. Please don't supply it as a 4-page PDF (single pages).

TOP TIP

Try making up your own folded sample to check it works before sending to us for print.

BLEED

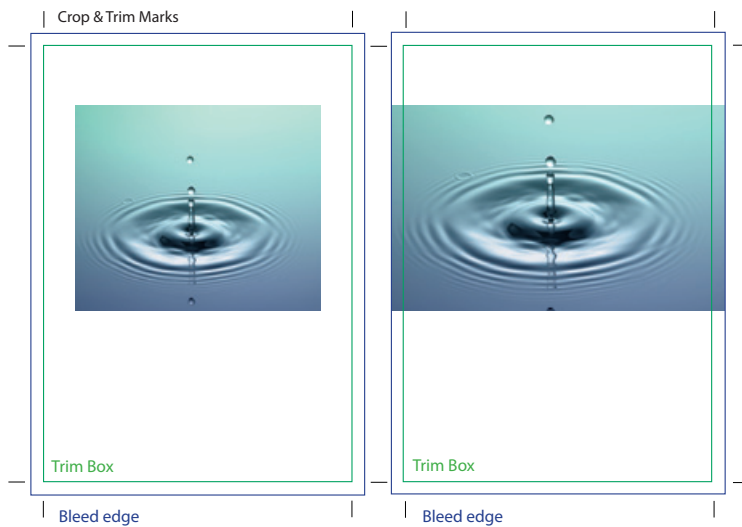

NO BLEED REQUIRED

BLEED REQUIRED

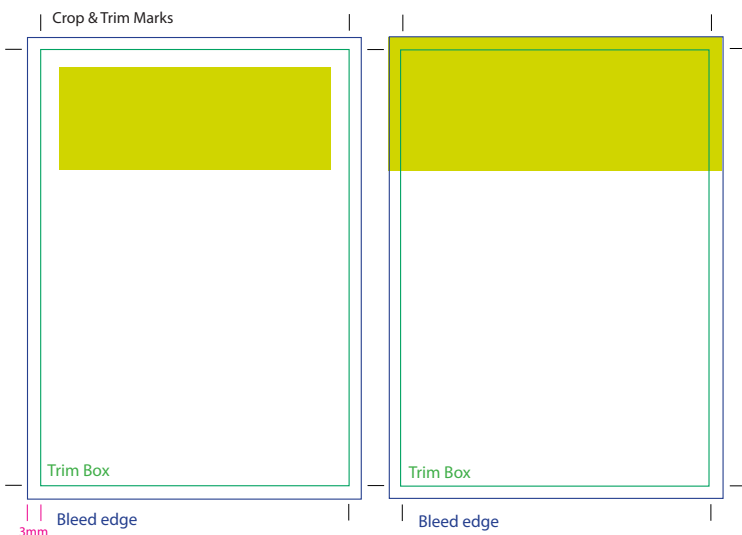

NO BLEED REQUIRED

BLEED REQUIRED

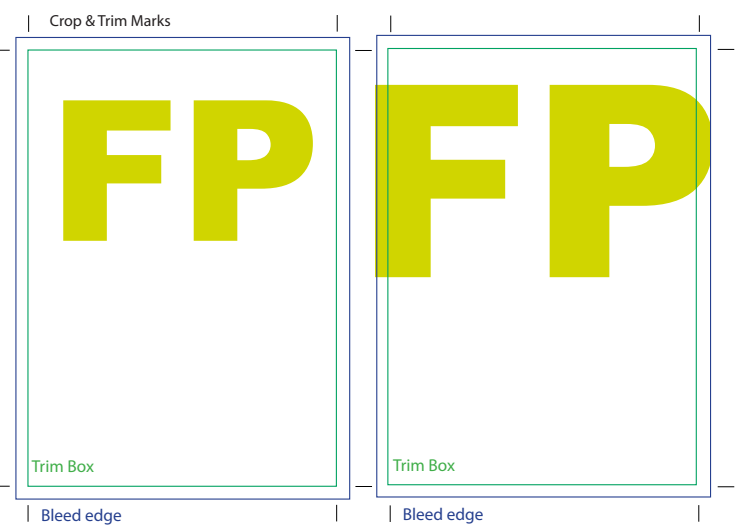

NO BLEED REQUIRED

BLEED REQUIRED

BLEED

Ensure all jobs have 3mm bleed if required. To determine if bleed is required please see diagrams on this page.

Bleed is required when images, colour or text go right to the edge of your page. To create a bleed simply extend your image(s), colour(s) or text 3mm over the edge of the page

PLEASE NOTE: If making a PDF for print, please make your PDF page size large enough to incorporate the bleed i.e. if your flyer is A5 with bleed, make your PDF page size A4, etc.

PLEASE NOTE

Any artwork supplied without bleed will automatically be enlarged to cater for this. If you have text close to the edge it may be fractionally cut off once the file has been enlarged.

CROP MARKS & TRIM BOX

Please always make your PDF with crop marks. These should be software-generated and added at the PDF-making stage (by ticking the 'Crop Marks' option).

Please also try to ensure your PDF has a trimbox. This can be checked by going to Preferences, Page Display, Page Content and Information, then ticking 'Show Art Trim and Bleed Boxes'. The trimbox will show up as a green line (or may show up as red if the artbox is in the same position as the trimbox). If your PDF does not have a trimbox, this can be set by selecting the Crop tool, double-clicking on the PDF, then under Crop Margins change 'Crop Box' to 'Trim Box' then set the correct values. If your trimbox should be 3mm in from the PDF page edges for example, then set Top, Bottom, Left and Right Values as 3mm.

TOP TIP

For a more professional look, keep a quiet border of at least 5mm from the trimmed edge of your artwork. See page 8 for details.

COLOURS

SPOT COLOURS



Ensure all colours in spot colour jobs are assigned Pantone colours (or are 'Black'). CMYK and RGB colour used in spot colour jobs will result in your job being rejected.

PLEASE NOTE: Do not use fountain fills in spot colour jobs as this will cause your job to be rejected.

RGB COLOURS



Do not use RGB colour in full colour jobs as the resulting colour may not be as expected once converted to CMYK for print.



RGB BLACK



Please note if you use RGB black (R 0 G 0 B 0) as a vector fill colour this will be automatically converted to CMYK black (100%k) by our workflow. Please also avoid having vector RGB black joining bitmap RGB black in your design as the join will be extremely noticeable once the conversion has taken place.



OVERPRINT COLOURS



If you accidentally set a fill or line to overprint, the final printed job will NOT look as it does in your design file, since all inks are transparent.

(Top Tip: Once you have created your PDF for printing (see page 9) view it In Acrobat Professional and go to the drop down menu Advanced/Print Production and activate Overprint Preview. In this view you will be able to see if you have inadvertently left any Overprints on your job. Try it with this Technical Guide PDF. Overprints are also identifiable by printing separations.)

BLACK



Ensure all black text and fills have the colour value C0 M0 Y0 K100. Try to keep text below 12pt in black whenever possible, as small coloured text may not look as sharp once printed. Large solid areas of black can be 'beefed up' with the addition of 60% Cyan (C60 M0 Y0 K100) resulting in a deeper looking black known as 'rich black'.

SPOT TO PROCESS COLOUR CONVERSION



When Pantone colours are converted to CMYK for full colour printing a change in colour is inevitable, it is impossible to exactly replicate spot colours using CMYK inks.

Similarly, with RGB images, when they are converted to CMYK, there is a colour shift.

Allow for this colour shift when designing your job.

VECTOR/BITMAP COLOURS

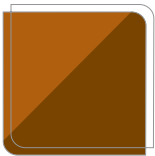

Areas of colour which have vector fills will appear different to areas of colour which have bitmap fills **once printed** even when the colour values are identical.

This means that a 'join' will be visible where vector colour meets bitmap colour. This will be more pronounced if RGB colour has been used after the conversion to CMYK has taken place.

The solution is to extend your bitmap colour out in a bitmap package (such as Photoshop) avoiding the joining of vector and bitmap colour completely.



FOUNTAIN FILLS & TRANSPARENCIES



Do not use fountain fills in spot colour jobs as this will cause your job to be rejected. Fountain fills in full colour jobs are fine.

If you have a spot colour job containing a fountain fill please supply us the native design file as File Assist and we will convert the fountain fills to a printable format.

Do not use transparencies in Microsoft Word or Publisher as this will result in your job being rejected. Please flatten any transparencies in Adobe Illustrator or Indesign prior to submitting your file.

If transparencies are present, please ensure that you do not use multi-layer transparencies (two or more transparencies sitting on top of one another) as this may cause problems when your file is processed through our PDF workflow, and may not give the desired end result.

Do not use transparencies in any document which contains spot colours.

The flattening of transparencies and the conversion of spot colours to CMYK occur during the same process, and this simultaneous double-conversion can often be too complex for our software to give an accurate end result.

INK COVERAGE



Try not to exceed 300% ink coverage in any of your chosen colours in your design file (work out the total percentage by adding the C, M, Y and K values together).

High ink coverage takes longer to dry and may result in set-off (colour from one side of your job getting transferred onto the other side of your job leaving a mark) and a delay to your job.

Please note that our corrective software will reduce any ink coverage between 340-400% down to 340% by altering the CMYK values. It does this in such a way as to still give an accurate end result and produce a colour very similar to the original intended colour (in fact you may not notice any difference).

You can avoid this happening, though, by keeping all of your colours to a maximum of 300-340%.

ARTWORK ELEMENTS

IMAGES



Try to ensure all images in your design file are high-res, the standard for which is 300dpi (dots per inch). The lower the dpi the worse your image(s) will look when printed, so please bear this in mind when scanning, manipulating or sourcing images for your job.

PLEASE NOTE: Images and logos saved from websites are most likely to be between 72-96dpi and are therefore unsuitable for print.

We highly recommend images to be CMYK, any RGB images will be converted to CMYK in our workflow which may result in a small colour shift (see p6 for details).

Sourcing Images - always try and use professional images, low quality images will only downgrade your designs. Images can be purchased from www.shutterstock.com or similar.

! NOTE:

Anything above 450dpi may be downsampled to 300dpi in our workflow.

FONTS



Fonts in your artwork

PDF – ensure you embed all fonts when making your PDF.

EPS – ensure you convert all fonts to outlines when making your EPS.

QUIET BORDER

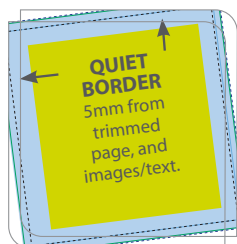

A “Quiet Border”, (i.e. an area where no text or logos should be present), of at least 5mm from the trimmed edge of your artwork should be observed. This will avoid any part of your design appearing too close to the edge of the page and will give your job a more professional appearance.

For A5 - A4 booklets we recommend 10mm quiet border for a much better finish.

HAIRLINES

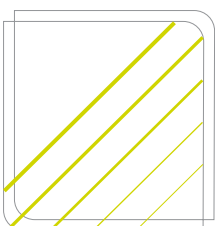

Hairlines are ‘device dependent’.

Because hairlines are device dependent they could print differently on different printers. Often they may look fine on your 300dpi laser printer but will disappear on our 2400dpi press. Therefore avoid hairline text and lines - use 0.25pt.

PREPARING YOUR FILES

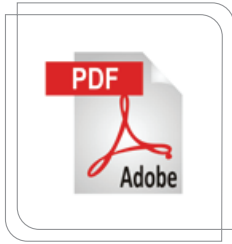

EPS files **MUST** be supplied with crop marks to show where the job is to be cut.

COLOUR PROFILES: When processing jobs we use our own specific colour profile. Please remember this when supplying files.

PDF CREATION

When creating your PDF to submit for print please use a recognised PDF-maker such as Acrobat Distiller to make your PDF. Using a design package's own PDF maker may result in your job being rejected.

Always save as a High Quality or Print Quality PDF.

If using Acrobat Distiller then choose PDF/X-1a:2001 from the drop-down list.

When creating your PDF please embed all fonts.

If your job has a bleed please ensure, you choose a large enough PDF page size to accommodate the bleed i.e. if you design an A6 flyer with a bleed, make your PDF page size A5.

Create your PDF with crop marks if possible.

Supply all files as 1up as we will deal with the imposition at this end.

Please always view your PDF with Output Preview open before submitting it for print as this gives the most accurate representation of how the file will look once printed, and may flag up errors that aren't visible without Output Preview open.

SUPPLYING FOLDED WORK

Please supply folded work as a double-sided 2-page file (or 2 single files with the file which is to be the outside of the leaflet clearly named), not a 3-page or 4-page file.

PREPARE YOUR OWN MOCK UP

If your job is to be folded, we recommend printing it out and make a folded mock up to check that it backs up properly, and that each section is orientated properly.

DOWNLOADABLE TEMPLATES



When designing a job, if you are in any doubt as to the correct sizes/proportions, we have templates available on request.

Use these as a guide when designing your job, then remove them before supplying us the artwork for print (except when supplying artwork for folders. Please see 'Folders', Page 13).

COLOUR VARIATION

Due to the complexities involved in printing there are a number of other factors to consider as these will affect the finished look of your job

COLOUR PROFILES

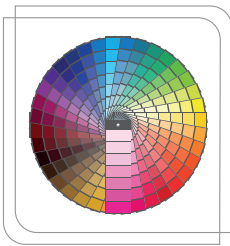

The output press profile we use when sending to print is ISO Coated fogra 27 so all images within your file will be converted to this profile. Any profiles other to this embedded in your file will be overwritten.

If you wish we can send you a copy of this profile to use when designing your artwork, though generally speaking this won't be necessary as this industry-standard conversion profile gives a consistently good result.



NOTE:

Output press profile we use when sending to print is ISO Coated Fogra 27.icc

PAPER STOCKS



The type/colour of paper you chose for your job may affect the final printed colour of the job itself, as all inks are transparent.

So if your job is printed on an off-white paper, this may have a slight effect on the ink colour i.e. it may turn out slightly darker than anticipated.

There will be a visible difference in colour between a job printed on coated paper and one printed on uncoated.

So if you were to get full colour letterheads on 120gsm bond (uncoated) printed along with full colour business cards on 400gsm silk (coated), any common colours may appear different on the final print.

Gloss and matt lamination will have a noticeable effect on the appearance of your printed colour, so please bear this in mind when you are designing your job (especially full colour business cards which will always be matt laminated after print).

If you have a printout of your job which has been produced on an ink jet or laser printer please note that the colours may appear different to the colours on your final litho-printed job.

Refer to process Pantone Book for accurate preview of colour,

INK TOLERANCE

Due to the ink tolerances involved in the four colour printing process, slight variance in finished printed colour is inevitable.

This means that although your job will be printed within tolerance, and to ISO standards, the finished colour may turn out to be slightly different to how you anticipated it, and may not be an exact match to your original colour in your design file.

On jobs with multiple setups (especially booklets) there may be a variance in colour within the job itself, but this variance will be slight (if at all) and always within tolerance.

Subsequent reprints may differ in colour slightly from previous print run(s), but this is perfectly normal and again will always be within tolerance.

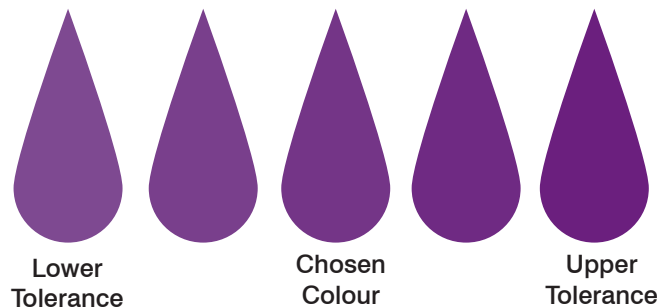

SCREEN COLOURS

When viewing the colours in your job on-screen you are looking at colour which is made up of red, green and blue light, and these colours cannot be exactly replicated with ink on paper. How the colours appear to you on-screen will also vary hugely depending on how/if your monitor is calibrated.

Please always choose your colours from a Pantone book to give a predictable result. Please also note that the colour/content of your PDF as it appears on-screen will vary depending on which simulation profile you are using to view it in Acrobat, so please ensure you are not using a simulation profile for a web-based press. Our recommended simulation profile file is available on request.

LARGE FORMAT AND DIGITAL

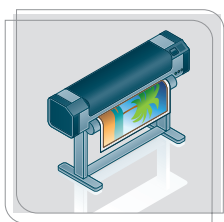

Large format printing utilises a different print technology to lithographic print. This means colours may not be an exact match to your litho jobs.

If your job is to be printed digitally, or is a large format poster or banner, please bear in mind that the final printed colours may not match exactly to the same colours printed using the litho process (standard jobs on a printing press) as large format digital printing uses an entirely different printing process and indeed a different type of ink. So if you are submitting jobs for both litho and large format digital and they contain common colours, please be aware of this slight variance in colour between the two processes.

SPECIALIST PRINT

BOOKLETS

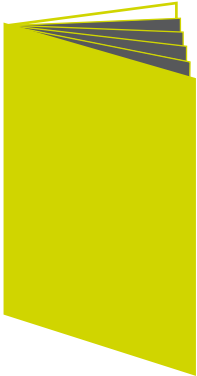

PAGE SIZES

A6 105 x 148mm **A5** 148.5 x 210mm **A4** 210 x 297mm

PAGE ORDER

The booklet page total must be divisible by 4. Please supply your booklets in single-page format running in the correct order from start to finish i.e. a 20 page booklet will run from pages 1-20, page 1 being the front cover and page 20 being the back cover (please do NOT place the back cover on Page 1).

Please do not supply your booklet as printers' pairs or as spreads.

CREEP

The closer you get to the centre pages of a booklet, the more has to be trimmed off the page edges. Our imposition software does make allowances for this. However, it is recommended that you do not have text (especially page numbers) or images too close to the edges of your booklet pages. A gap of at least 5mm is recommended on all edges.

SUPPLYING YOUR BOOKLET

Please note our preferred format for booklets is a single multi-page PDF running in the correct order i.e. if you are supplying artwork for a 12-page A5 booklet you must supply one PDF which is 12 pages long, each page being A5 and running in the same order as the finished printed booklets are to run, from front cover through to back cover.

TOP TIP

Avoid content which crosses two adjoining pages.

SPOT UV



When supplying Spot UV jobs you must also supply a PDF of the areas which need spot UV'd. The PDF should consist of black solid shapes in the exact position where the spot UV is required, ideally 1mm bigger all round to allow for easier register. Please add an outline to any text which needs spot UV'd, again to help with register (the larger the text, the thicker the outline should be added).

It is not recommended that small text is Spot UV'd.

LARGE FORMAT

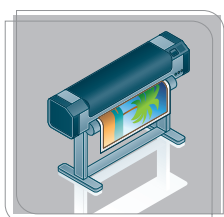

POSTERS

All posters should have 3mm of bleed regardless of their finished size and quiet borders should be at least 10mm. However, if the finished product is to sit inside a frame allow for a larger quiet border for size of the frame. Graphic resolution should be no lower than 150dpi.

BANNERS

Banners require a 15mm bleed, which will allow the image to wrap round for stitching the edges. A quiet border of at least 10mm is recommended and images no lower in resolution than 150dpi.

FORME CUT

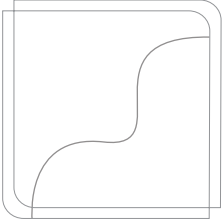

When supplying Forme Cut jobs you must also supply a PDF of the cutting forme you require. This should consist of a black hairline in the exact shape and size of the cuts/creases you require, which will be used to produce a cutting forme for your job. Cuts should be denoted by a solid black hairline, creases should be denoted by a dotted black hairline.

FOLDERS

There are 2 folder types to choose from, A4 or A5, both of which have a 3mm gutter and are oversized to accommodate your chosen paper size (i.e. the A4 folder will accommodate A4 sheets with room to spare).

Before designing your folder, please refer to the relevant folder template, and use this as your guide when designing your folder. These templates are available on request.

When supplying artwork for a folder, please send us 2 files, one with the template visible (overlaid on your artwork) so that we can check that the artwork meets our specifications, and one with the template removed leaving only what you wish to be printed (it is this file which will be proofed/printed) as the visual below indicates.

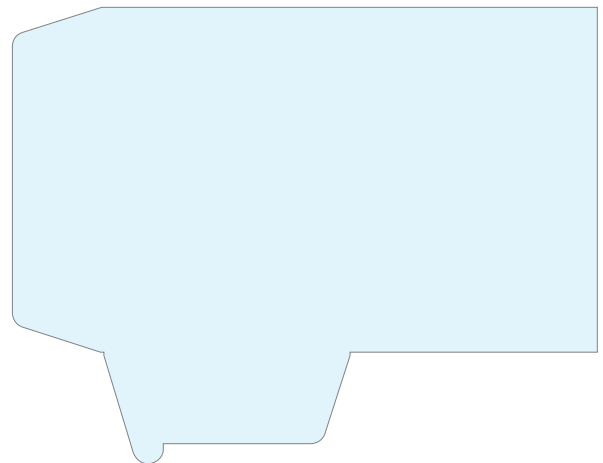
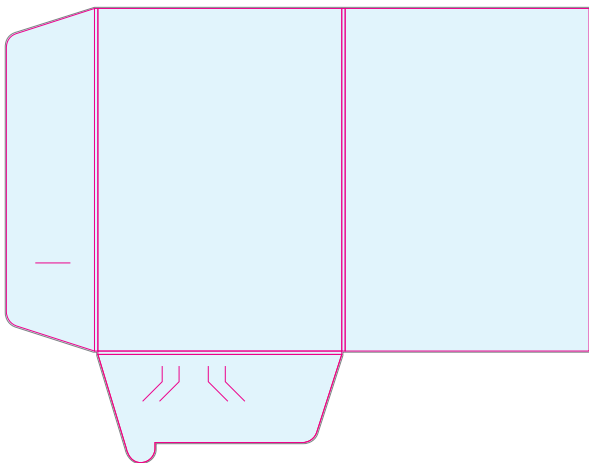

TOP TIP

Please also specify at point of order whether you wish to have business card slots on your folder, as these are optional.

NOTES

NOTES

